

PLAN

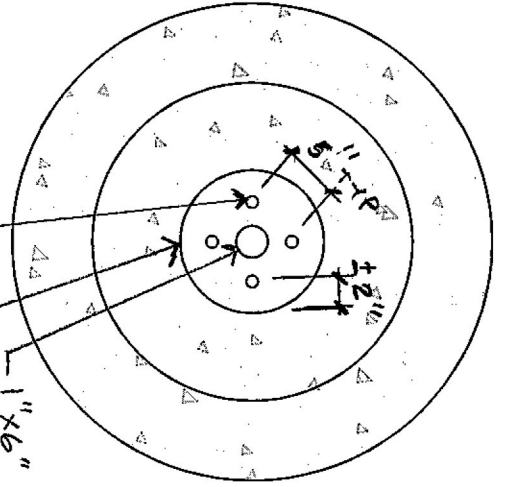

- 1" x 6" FERRELE LOOP
THREADED INSERT, w/
PLASTIC THREADED PLUG
- 1/2" x 10" Ø GALVANIZED
STEEL PLATE
- 5/8" x 18" THREADED J-BOLTS
(IMBEDDED INTO CONCRETE,
FOUR (4) PER PLATE

PLAN

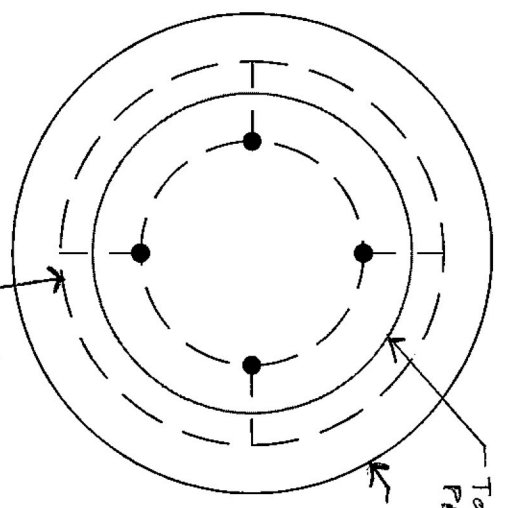

- #4 REBAR
DISTRIBUTED EVENLY,
10" O.C. MAX

ELEVATION

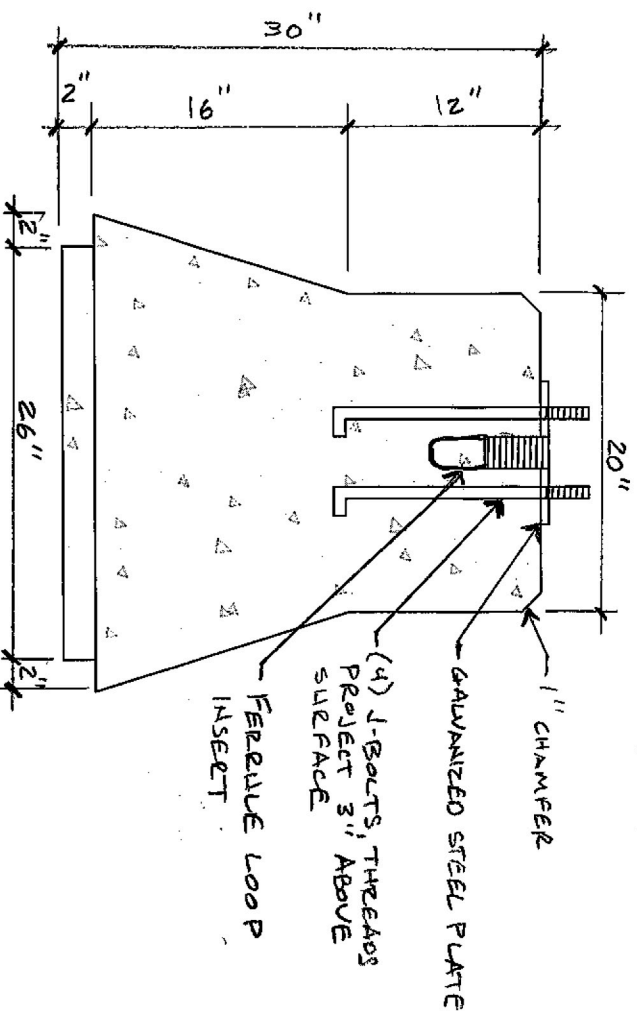

- 1" CHAMFER
- GALVANIZED STEEL PLATE
- (4) J-BOLTS, THREADS
PROJECT 3" ABOVE
SURFACE
- FERRELE LOOP
INSERT

ELEVATION

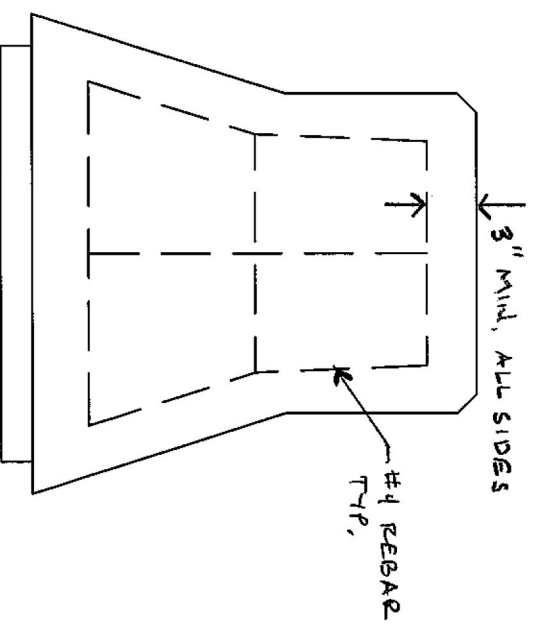

NOTE: ALL HARDWARE TO
BE GALVANIZED.

PEDESTAL AT T&C MARKET

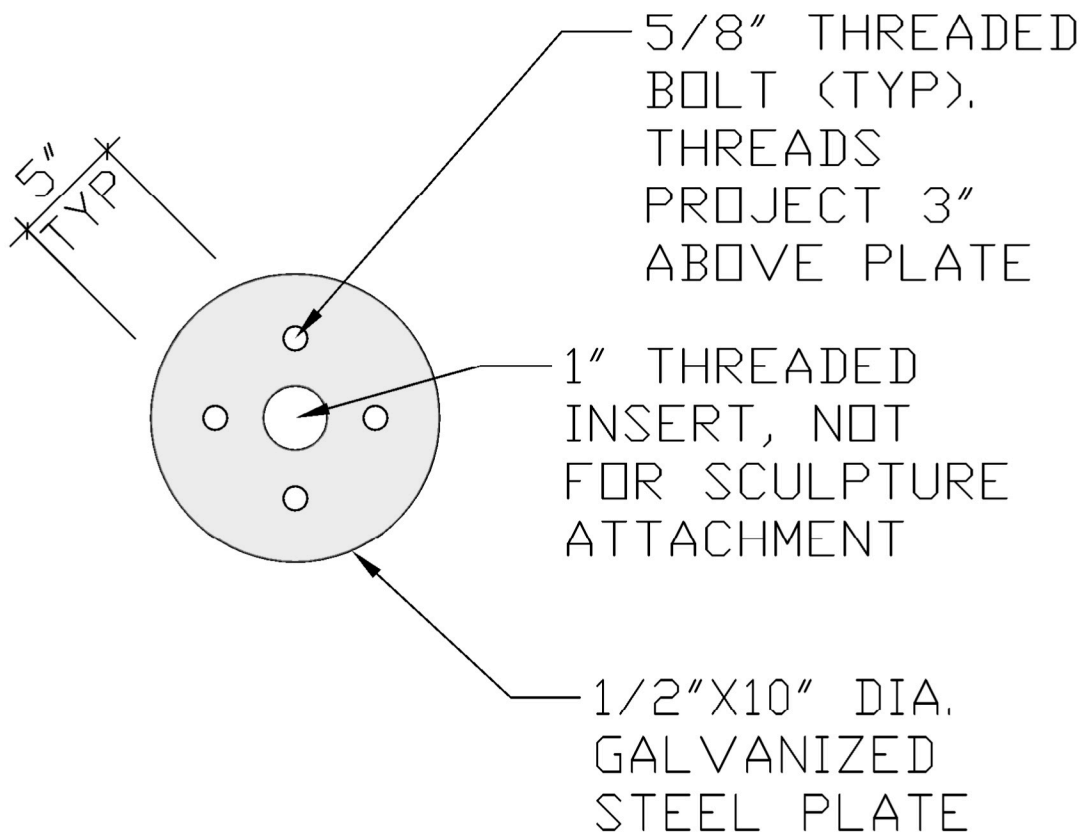

CONNECTION PLATE - WINSLOW WAY

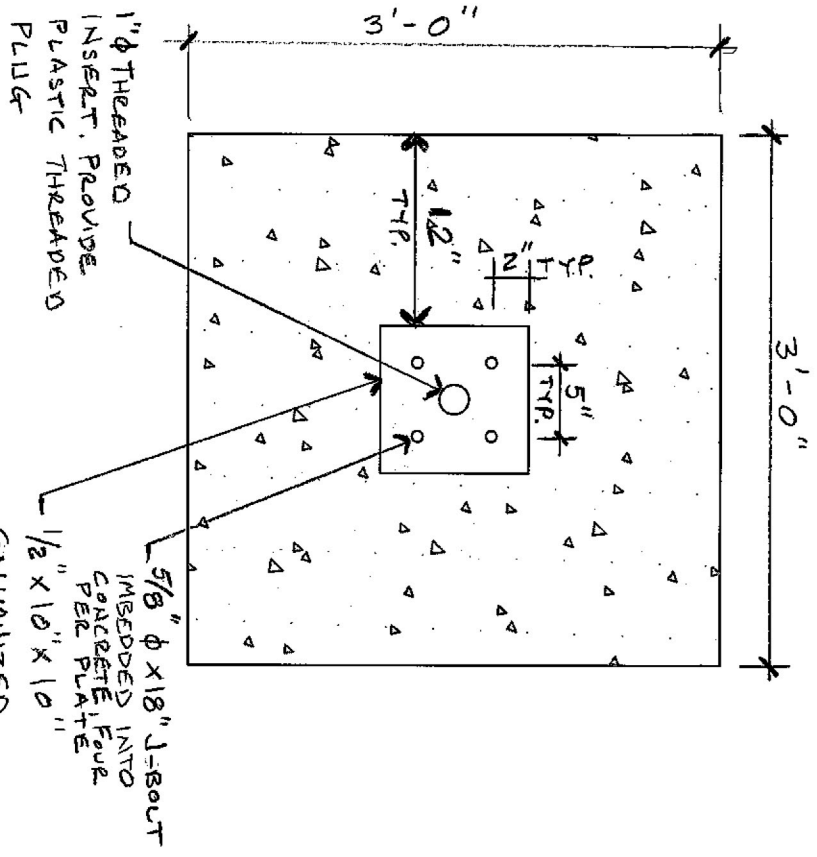

PLAN

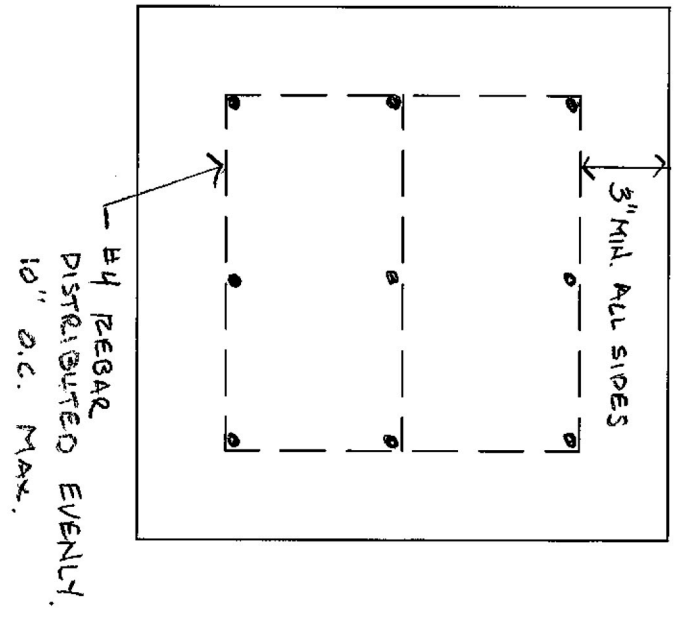

PLAN

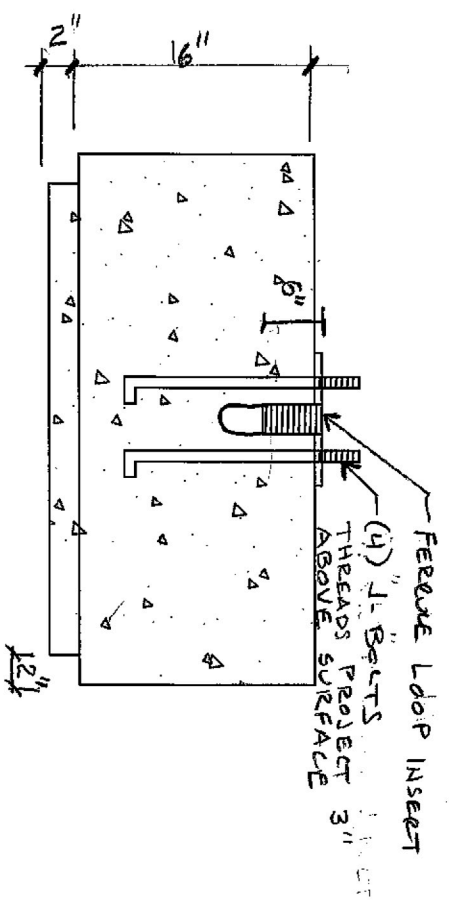

ELEVATION

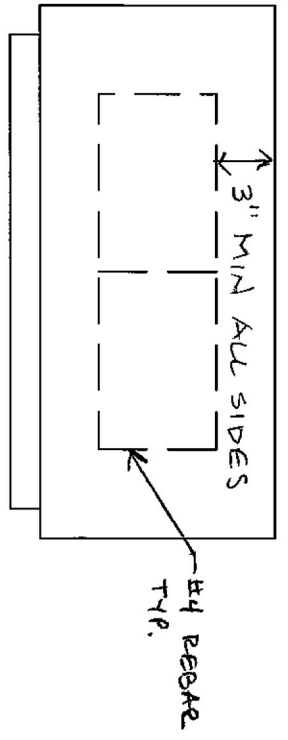

ELEVATION

PEDESTAL @ MADISON AVE PLAZA

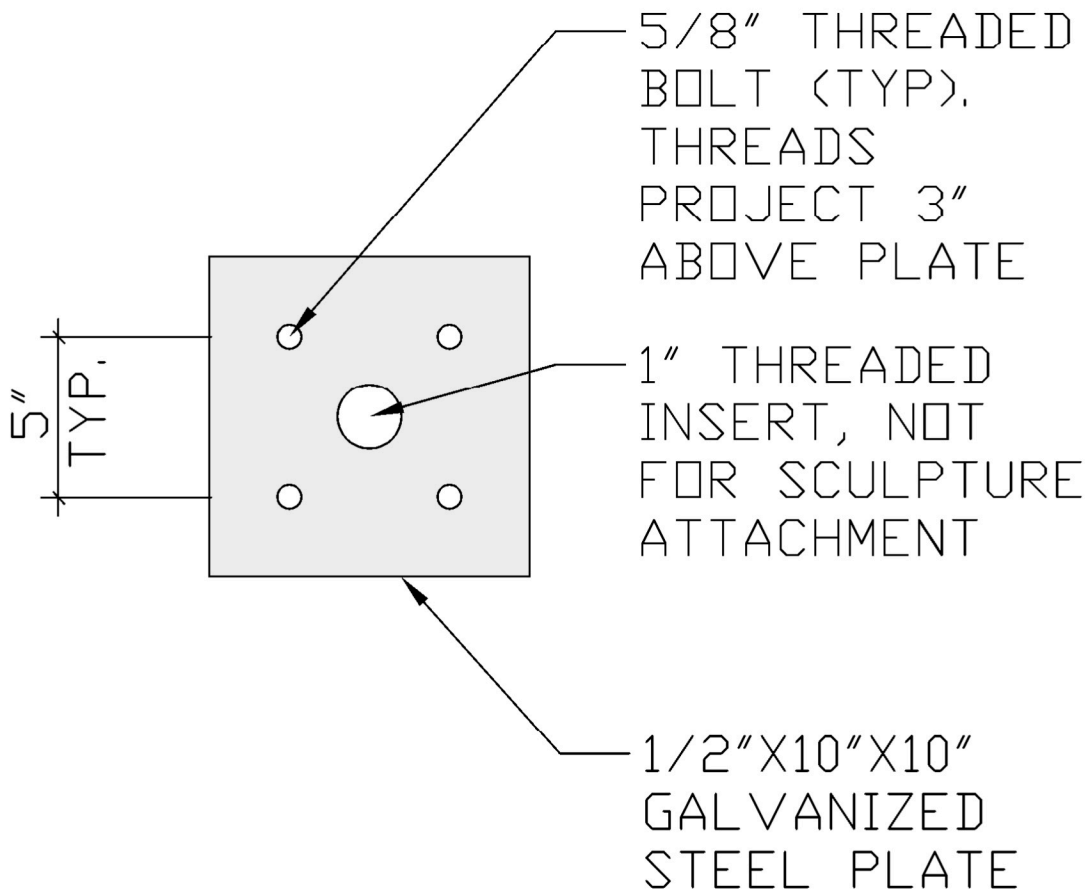

CONNECTION PLATE - S. MADISON OVERLOOK