

PEDESTAL AT T&C MARKET

NOTE: ALL HARDWARE TO BE GALVANIZED.

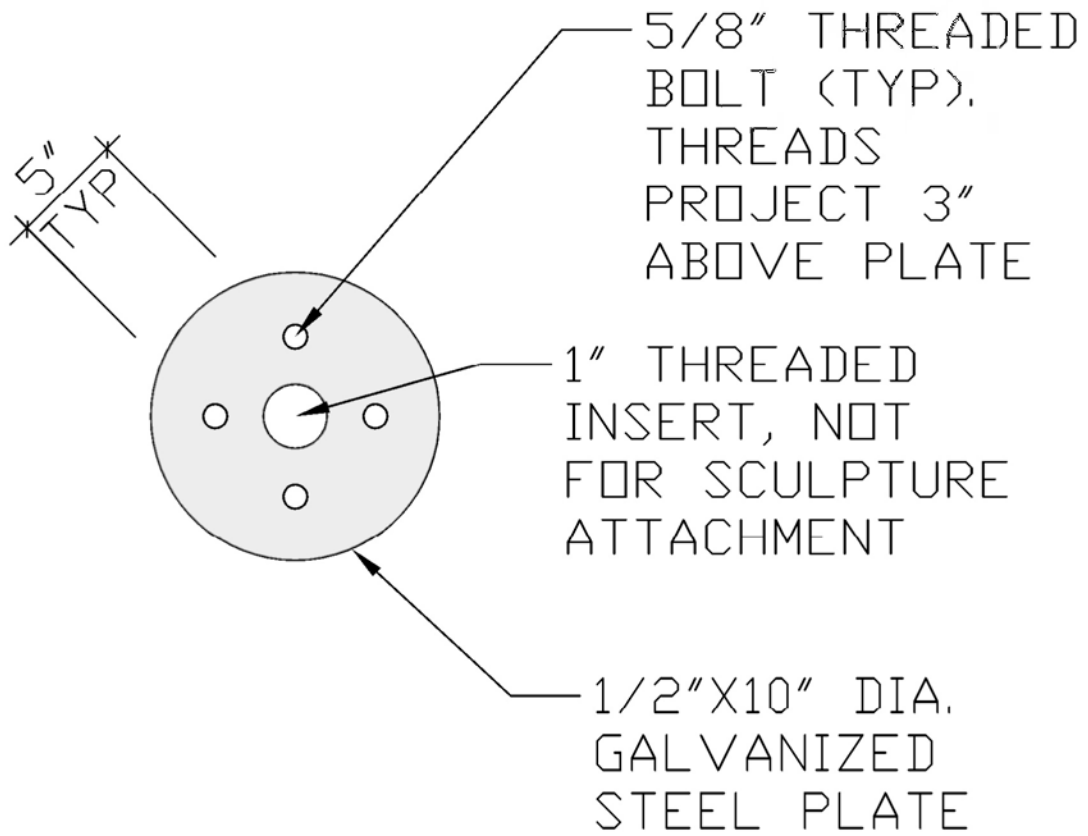

CONNECTION PLATE - WINSLOW WAY

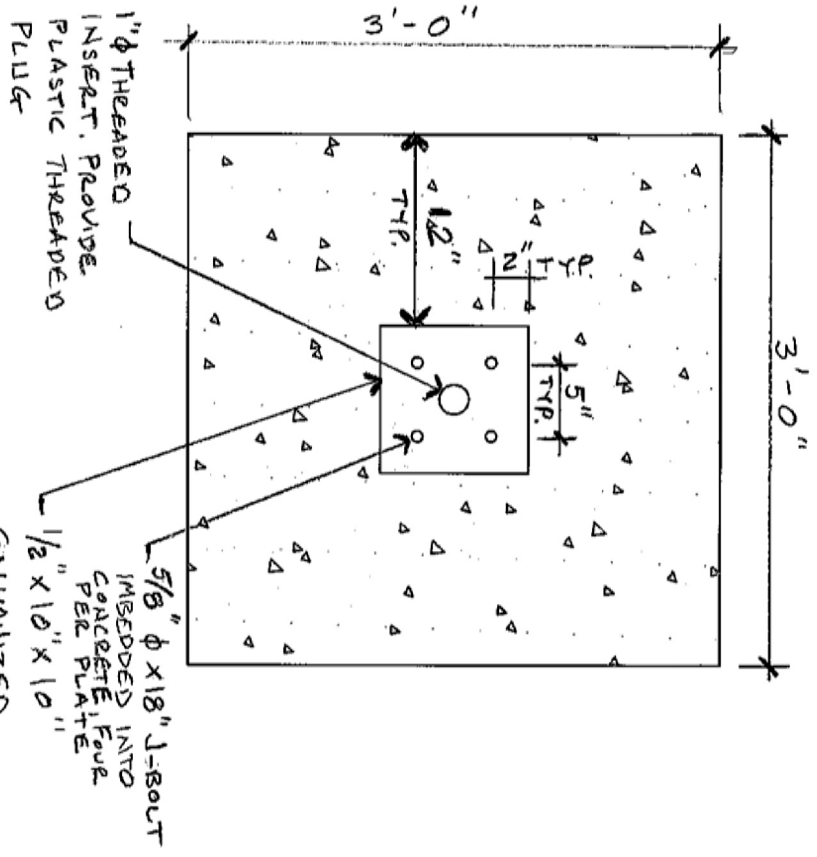

PLAN

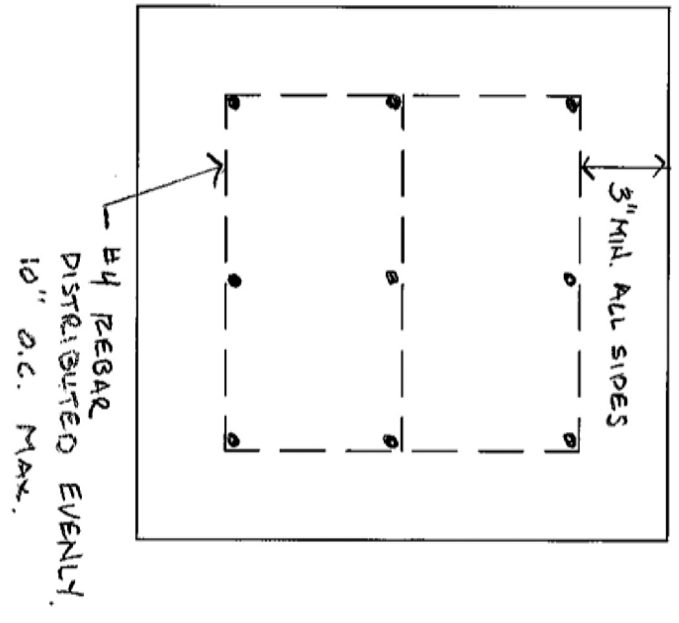

PLAN

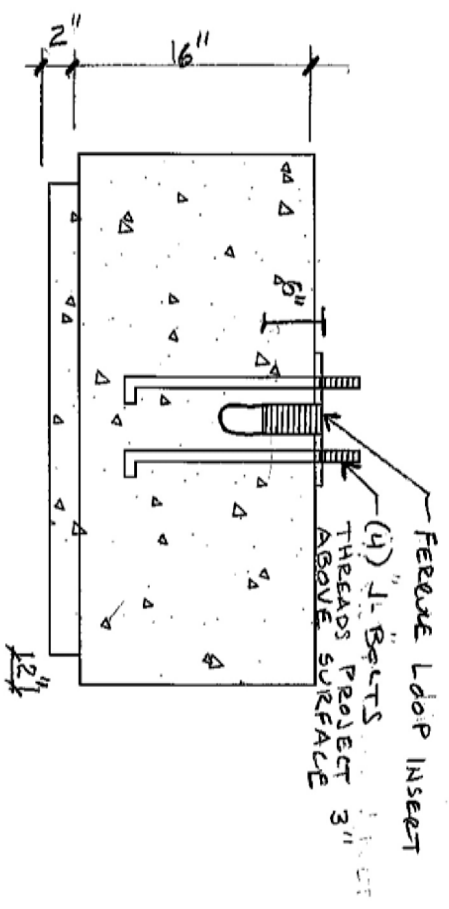

ELEVATION

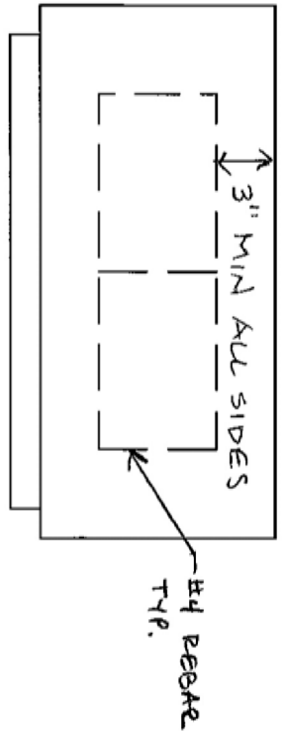

ELEVATION

PEDESTAL @ MADISON AVE PLAZA

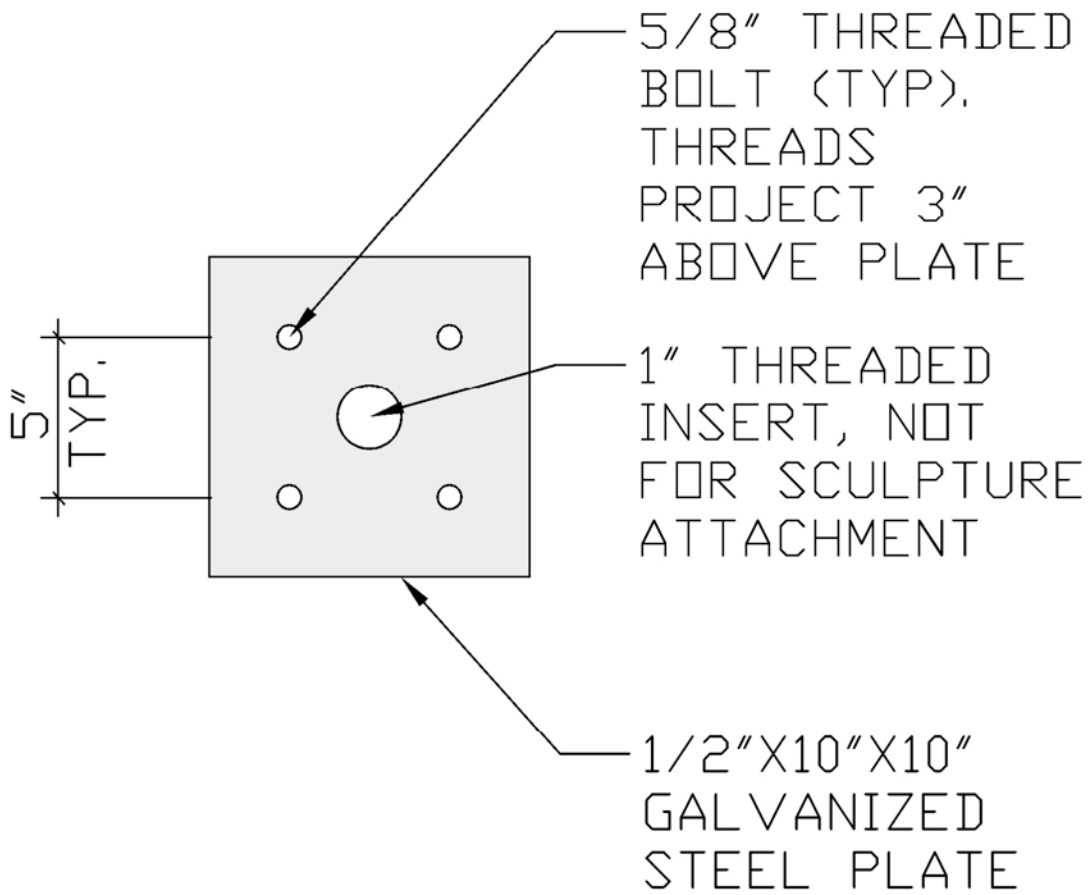

CONNECTION PLATE - S. MADISON OVERLOOK

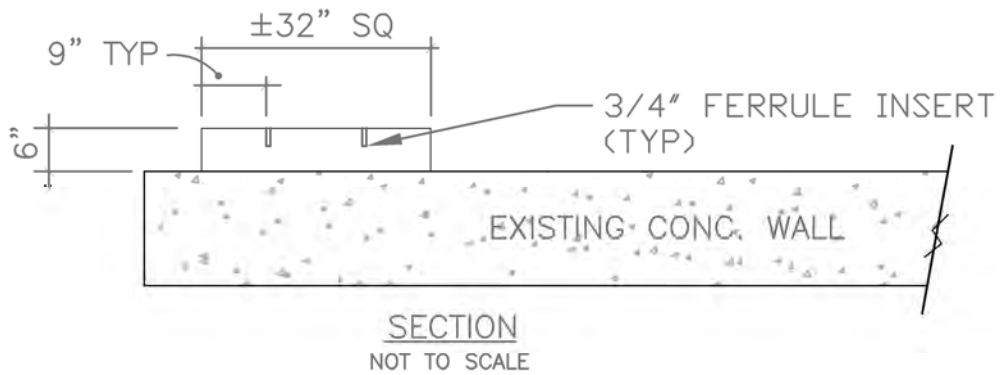
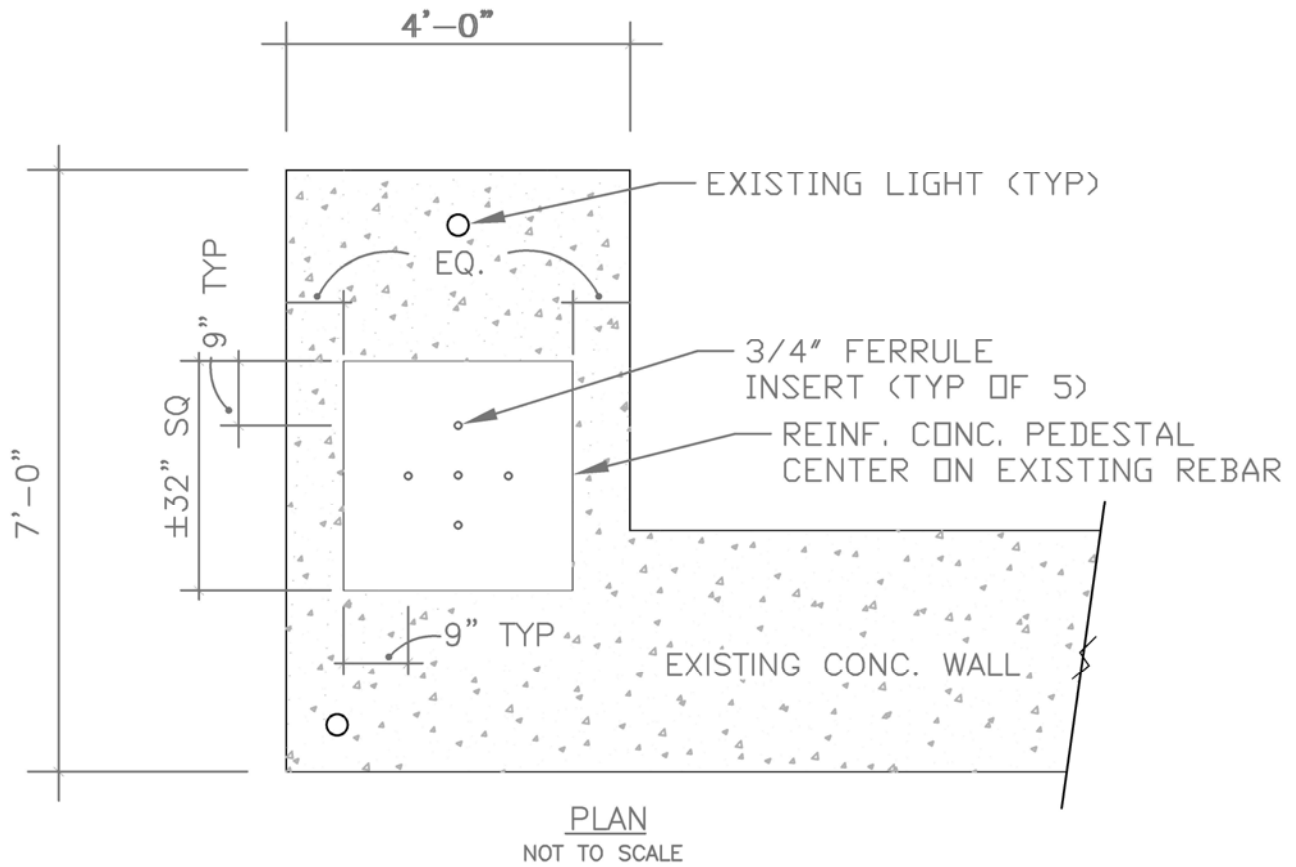

07-24-2020
DATE

City Hall Pedestal
Something New Phase 3



**CITY OF
BAINBRIDGE ISLAND**
**PUBLIC WORKS
ENGINEERING
DEPARTMENT**

1
NUMBER

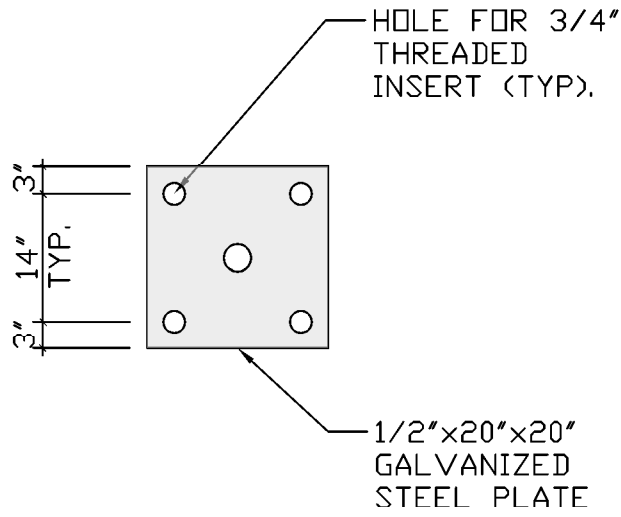

CONNECTION PLATE - WATERFRONT PARK

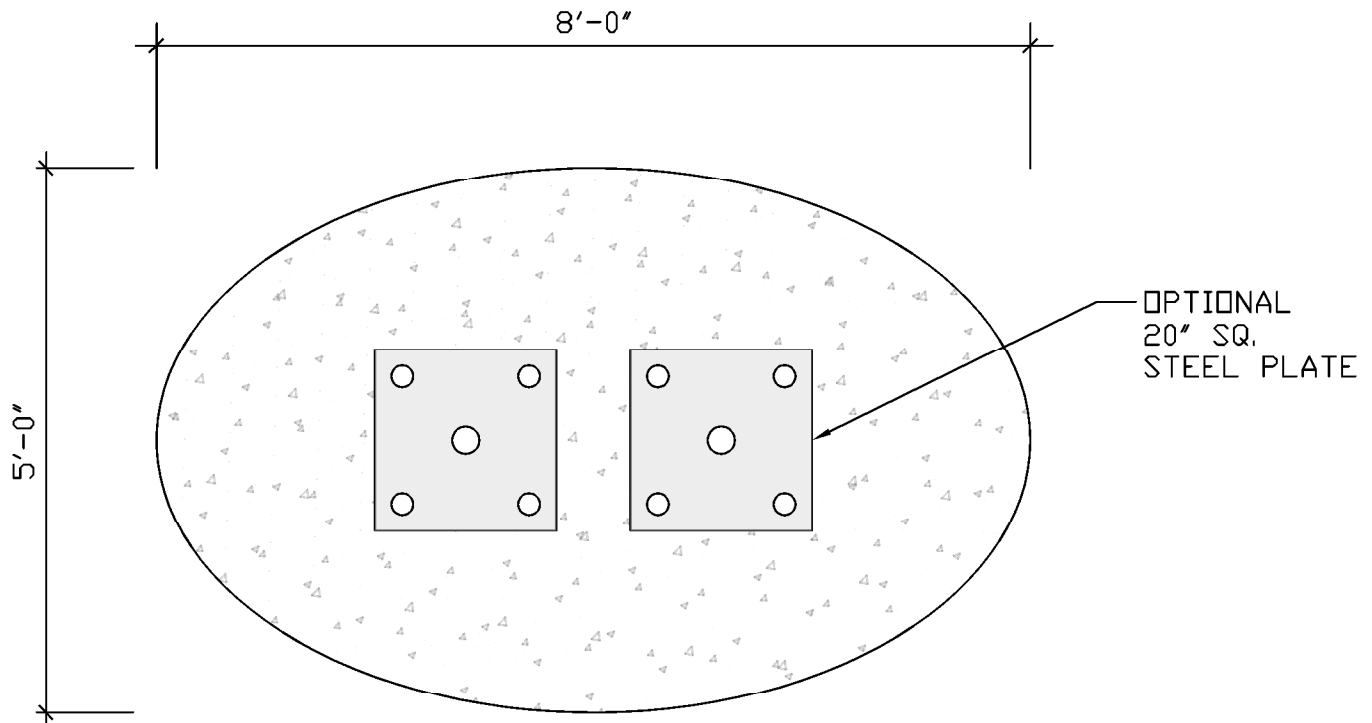

PLAN - WATERFRONT PARK PEDESTAL

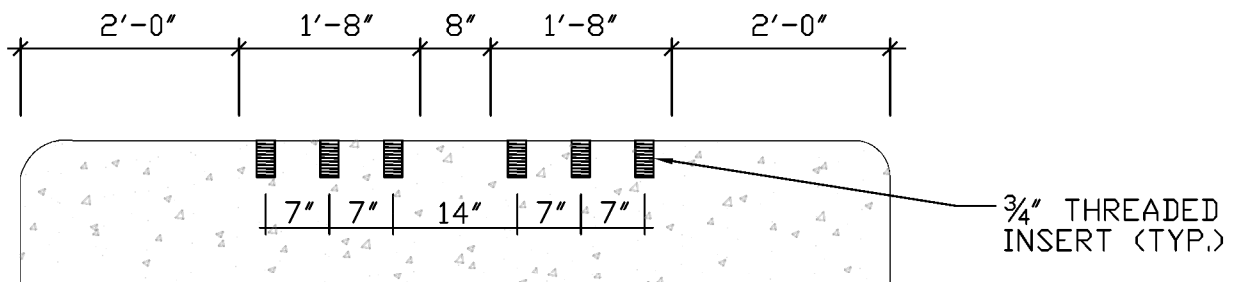

ELEVATION - WATERFRONT PARK PEDESTAL