

- NOTES:**
1. ARTIST SHALL PROVIDE BASE PLATE TO ALLOW FOR BOLTED CONNECTION TO CITY'S PEDESTAL. BASE PLATE SHALL NOT EXCEED DIMENSIONS OF TOP TIER AND SHALL PROVIDE 2" MIN. CLEARANCE SURROUNDING DRILLED/REAMED HOLES.
 2. ARTIST SHALL PROVIDE OVERALL DIMENSIONS (LxWxH), WEIGHT, AND CONNECTION DETAILS OF ARTWORK, FOR ENGINEERING REVIEW.
 3. DRILLING INTO CONCRETE PEDESTAL PROHIBITED.
 4. CITY SHALL FURNISH/INSTALL 5/8" DIA. BOLTS AND FENDER WASHERS TO SECURE ARTWORK TO PEDESTAL.

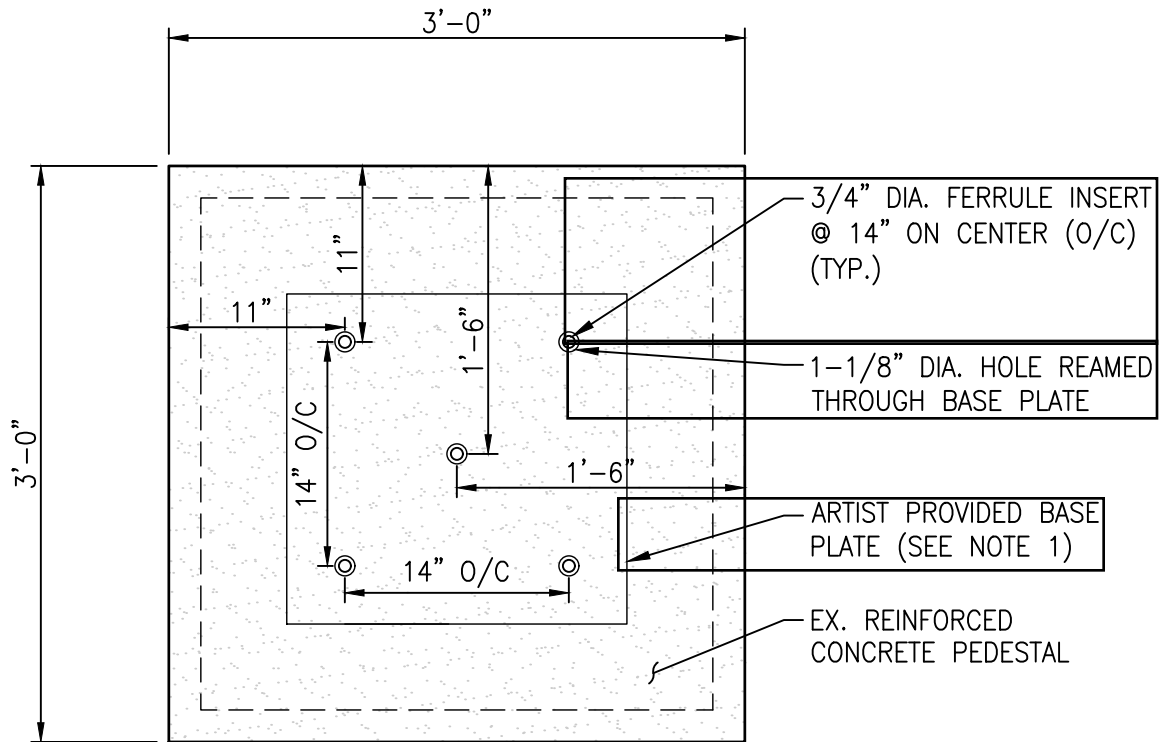

PLAN VIEW

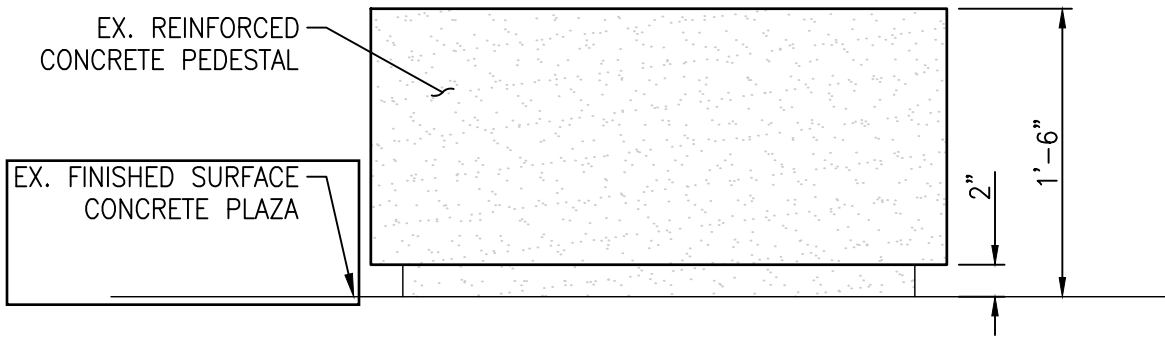

ELEVATION

NOTES:

1. ARTIST SHALL PROVIDE BASE PLATE TO ALLOW FOR BOLTED CONNECTION TO CITY'S PEDESTAL.
2. ARTIST SHALL PROVIDE OVERALL DIMENSIONS (LxWxH), WEIGHT, AND CONNECTION DETAILS OF ARTWORK, FOR ENGINEERING REVIEW.
3. DRILLING INTO CONCRETE PEDESTAL PROHIBITED.
4. CITY SHALL FURNISH/INSTALL 3/4" DIA. A32 BOLTS TO SECURE ARTWORK TO PEDESTAL.

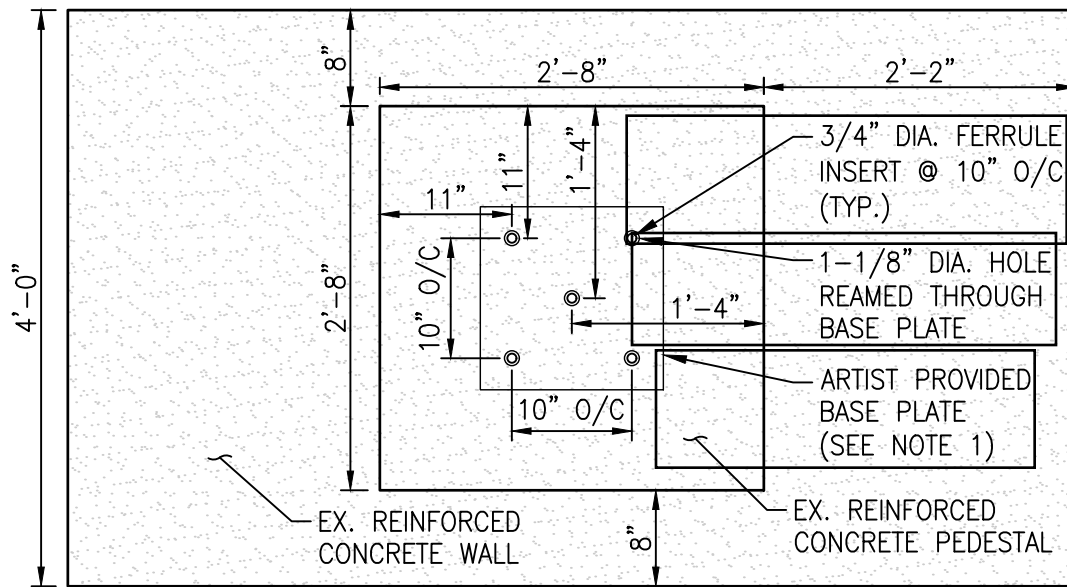

PLAN VIEW

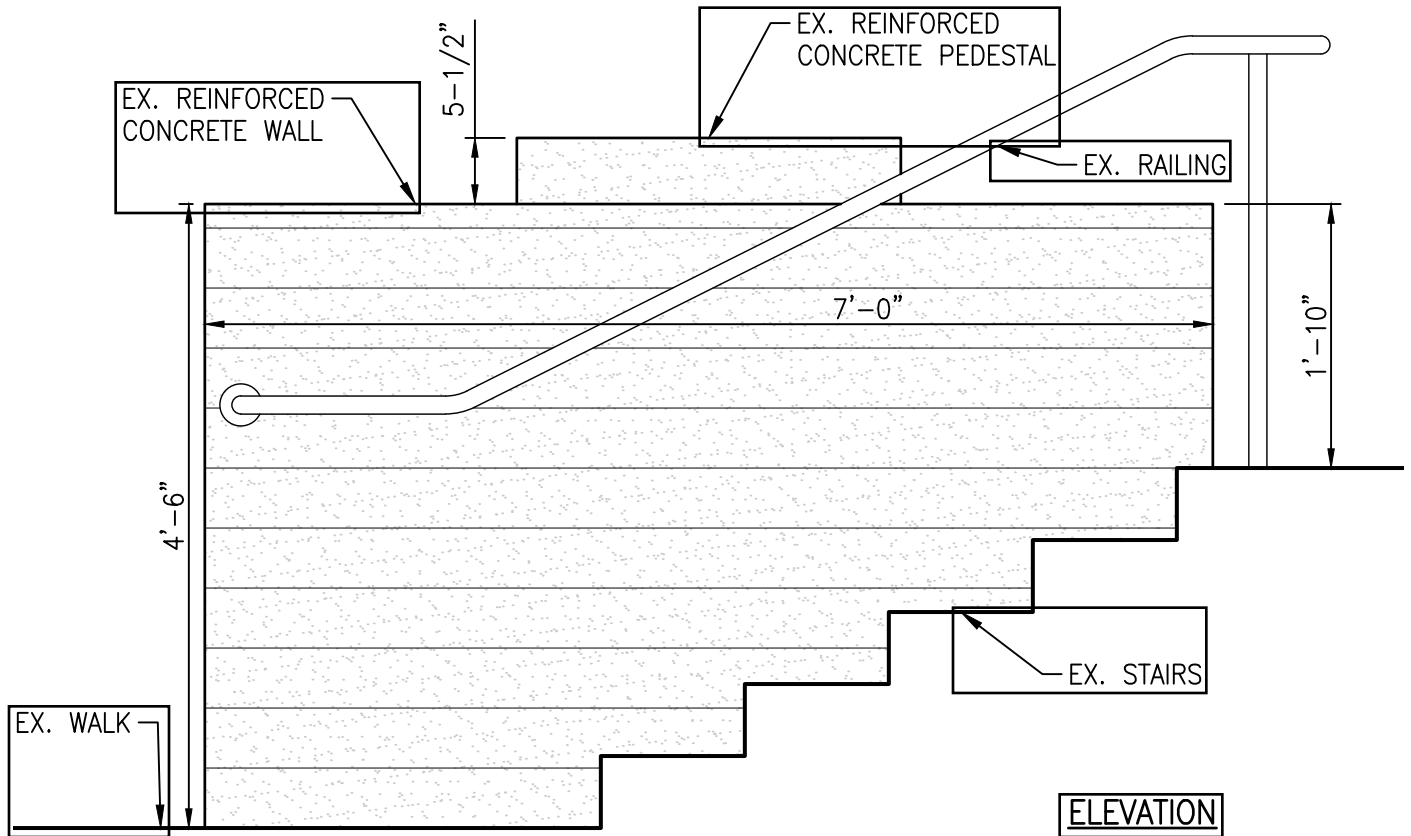

ELEVATION

NOTES:

1. ARTIST SHALL PROVIDE BASE PLATE TO ALLOW FOR BOLTED CONNECTION TO CITY'S PEDESTAL.
2. ARTIST SHALL PROVIDE OVERALL DIMENSIONS (LxWxH), WEIGHT, AND CONNECTION DETAILS OF ARTWORK, FOR ENGINEERING REVIEW.
3. DRILLING INTO CONCRETE PEDESTAL PROHIBITED.
4. CITY SHALL FURNISH/INSTALL 3/4" DIA. A32 BOLTS TO SECURE ARTWORK TO PEDESTAL.

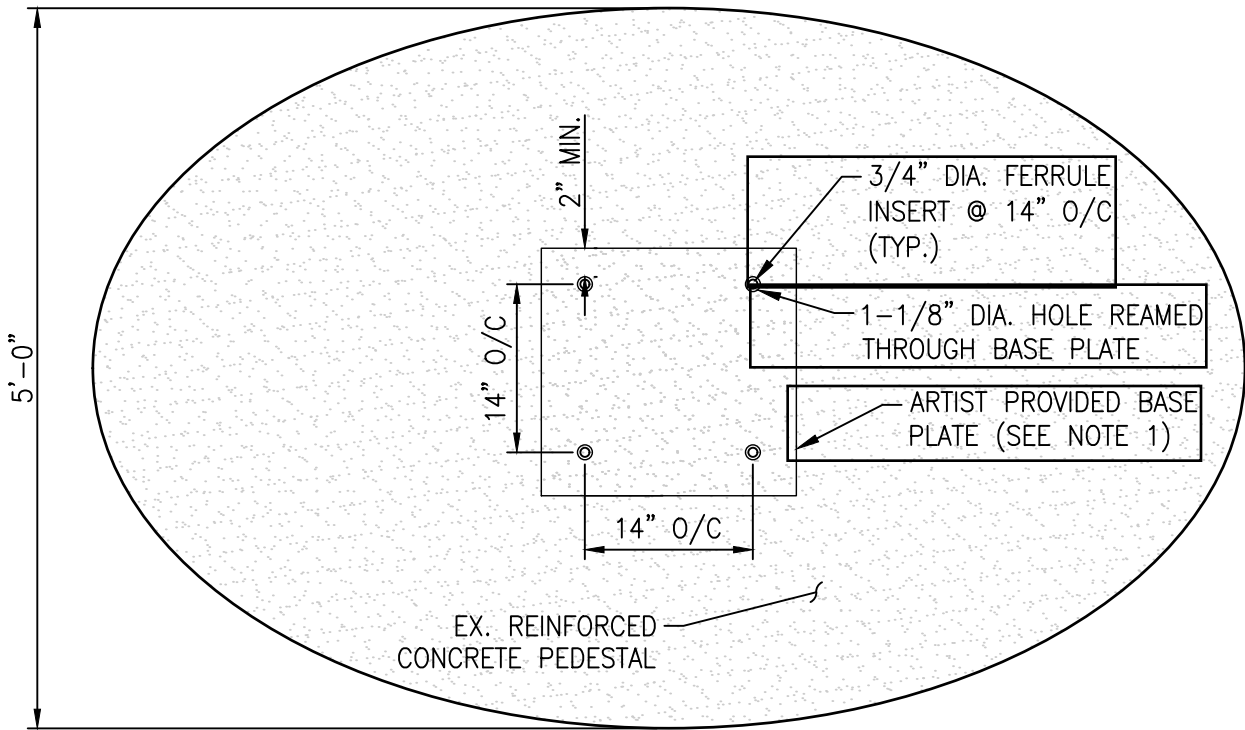

PLAN VIEW

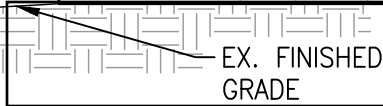
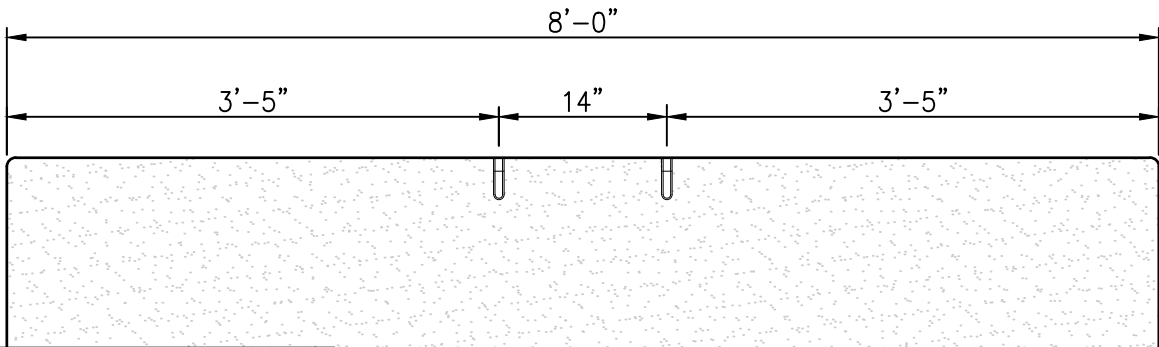

EX. FINISHED GRADE

ELEVATION

NOTES:

1. ARTIST SHALL PROVIDE BASE PLATE TO ALLOW FOR BOLTED CONNECTION TO CITY'S PEDESTAL.
2. ARTIST SHALL PROVIDE OVERALL DIMENSIONS (LxWxH), WEIGHT, AND CONNECTION DETAILS OF ARTWORK, FOR ENGINEERING REVIEW.
3. DRILLING INTO CONCRETE PEDESTAL PROHIBITED.
4. CITY SHALL FURNISH/INSTALL 3/4" DIA. A32 BOLTS TO SECURE ARTWORK TO PEDESTAL.